

# Model PT100SB

## 4, 6 & 8 WAY SUMMER BOXES



The PT range of 4, 6 and 8 way summer boxes are a perfect match to any PT load cell.

Fitted with liquid tight strain relief cable fittings. The PT100SB accepts a wide range of cable diameters.

Enclosed in a tough polycarbonate housing, easily accessible yet securely closed and positively sealed by way of its O ring screw on cover and external fixing holes.

Designed and produced for the installer, with simple to reach and positive control trim pots for load measurement correction.

All Summer Boxes contain an overall span trim to ease the requirements for indicator re-calibration after cornering.

The 6 and 8 way also contain section trim adjustment to enable trimming of load cell pairs or sections along a weighbridge.

## FEATURES

- Liquid tight strain relief cable fittings
- Accepts cables from 3.5mm ~ 8mm in diameter
- Accepts 2 to 8 load cell inputs with section pots in 6 and 8 way
- Span adjustment pots non-interactive
- Mounted in weather tight enclosure

## Specifications

|               | Approximate Adjustment % |               |            | Cable Size  | Sealing | Weight |
|---------------|--------------------------|---------------|------------|-------------|---------|--------|
|               | Load Cell (min)          | Section (min) | Span (min) |             |         |        |
| PT100SB 4 Way | 5                        | N/A           | 5          | 3.5mm ~ 8mm | IP66    | 0.30kg |
| PT100SB 6 Way | 5                        | 5             | 5          | 3.5mm ~ 8mm | IP66    | 0.40kg |
| PT100SB 8 Way | 5                        | 5             | 5          | 3.5mm ~ 8mm | IP66    | 0.45kg |



Manufactured in New Zealand

# Ordering Information

Detailed dimension drawings for the accessories are available at our web site.

| MODEL                | Part Number     | MODEL                | Part Number     | MODEL                | Part Number     |
|----------------------|-----------------|----------------------|-----------------|----------------------|-----------------|
| PT100SB 4 Way Summer | EPI100SB0004XXX | PT100SB 6 Way Summer | EPI100SB0006XXX | PT100SB 8 Way Summer | EPI100SB0008XXX |

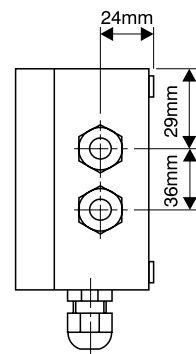
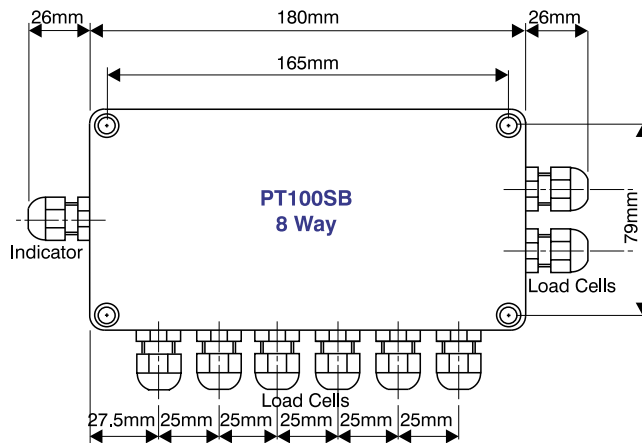
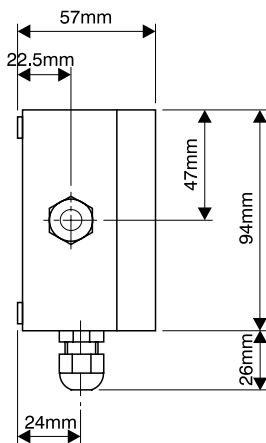
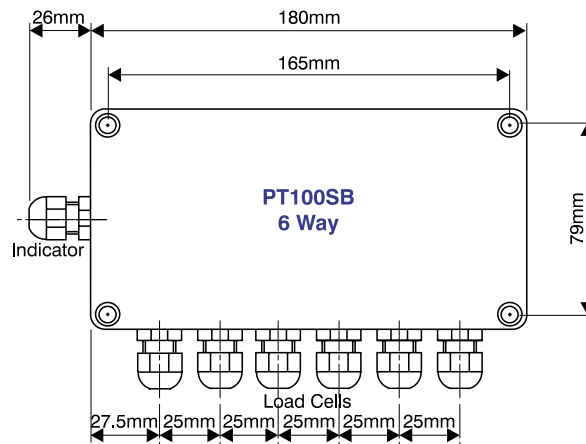
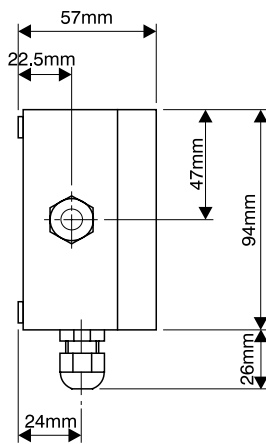
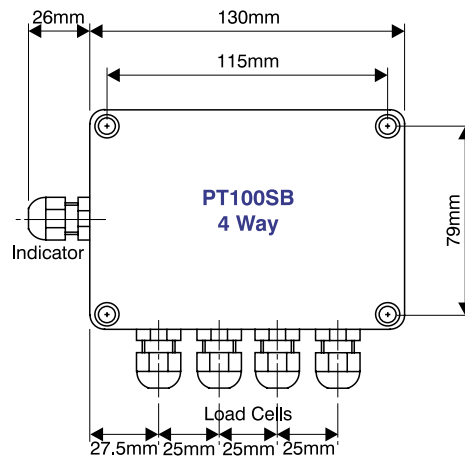
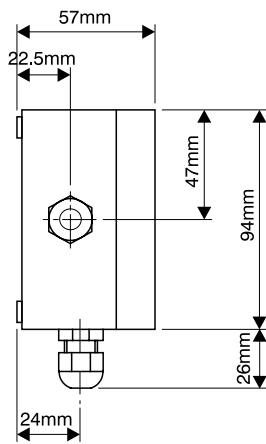

### PT Cable Colour Code

|            |     |       |
|------------|-----|-------|
| Excitation | +ve | Red   |
| Sense      | +ve | Brown |
| Excitation | -ve | Black |
| Sense      | -ve | Blue  |
| Signal     | +ve | Green |
| Signal     | -ve | White |

**NOTE:** Glands accommodate cable size 3.5mm ~ 8mm