

Innovative Measurement Electronics



PT Ltd.

PT200X
Digital Indicator
Quick Start Manual

Copyright

All Rights Reserved. No part of this document may be copied, reproduced, republished, uploaded, posted, transmitted, distributed, stored in or introduced into a retrieval system in any form, or by any means (electronic, mechanical, photocopying, recording or otherwise) whatsoever without prior written permission of PT Ltd.

Disclaimer

PT Ltd reserves the right to make changes to the products contained in this manual in order to improve design, performance or reliability.

The information in this manual is believed to be accurate in all respects at the time of publication, but is subject to change without notice. PT Ltd assumes no responsibility for any errors or omissions and disclaims responsibility for any consequences resulting from the use of the information provided herein.

SPECIAL NOTE

Trade Use

This manual may occasionally make reference to Trade Use settings. Some individual settings may not be legal for trade use. Please check regulations with the appropriate Weights and Measures Authority.

Table of Contents

1. INTRODUCTION	2
1.1. Approvals (for trade versions only).....	2
1.2. Manuals	2
2. SHIPPING CONTENTS	2
3. SPECIFICATIONS	3
4. WARNINGS	4
4.1. General	4
4.2. Configuration Issues	4
5. INSTALLATION	5
5.1. Electrical Safety	5
5.2. opto-LINK.....	6
6. CONNECTIONS	7
6.1. Cable Connections	7
6.2. DC Power (DC PWR + , DC PWR –).....	7
6.3. Load Cell Connection	7
6.4. Auxiliary Connections	9
6.5. Connecting Shields.....	13
6.6. Regulatory Sealing Requirements.....	13
7. INSTRUMENT SETUP	15
7.1. Calibration Counter.....	15
7.2. opto-LINK.....	15
7.3. Access Full Setup.....	16
7.4. Access Safe Setup	16
7.5. Exit Full or Safe Setup.....	16
7.6. Settings.....	16
8. ERROR MESSAGES	25
8.1. Weighing Errors	25
8.2. Setup and Calibration Errors	26
8.3. Diagnostic Errors	27

1. Introduction

This manual contains information on the installation, calibration and setup of the instrument.

1.1. Approvals (for trade versions only)

- C-tick approved and CE approved.

1.2. Manuals

For more information on this instrument refer to the **Reference Manual, Quick Start Manual or Communications Manual.**

2. Shipping Contents

The following table identifies the items shipped with the indicator. Please check that your packing box contains the specified items.

Shipped Items	Other Items (Optional)
<ul style="list-style-type: none">• Indicator• Operator Manual• Quick Start Manual• Trade Label (plastic)• U Bracket	<ul style="list-style-type: none">• opto-LINK Cable• Power Supply• Battery Pack with Charger• Captive Security Screws

3. Specifications

Performance		
Resolution	Up to 30,000 divisions, minimum of 0.25 μ V/division, 20 updates/second (Trade 4000 divisions at 0.8 μ V/division)	
Zero Cancellation	\pm 2.0mV/V	
Span Adjustment	0.1mV/V to 3.0mV/V full scale	
Stability/Drift	Zero: < 0.1 μ V/ $^{\circ}$ C (+ 8ppm of deadload max) Span < 8 ppm/ $^{\circ}$ C, Linearity < 20ppm, Noise < 0.2 μ Vp-p	
Excitation	5 volts for up to 4 x 350 or 8 x 700 ohm load cells (4-wire or 6-wire plus shield) Maximum total load cell resistance: 1,000 ohms	
A/D Type	24bit Sigma Delta with 8,388,608 internal counts	
A/D Conversion Rate	20Hz with FIR filtering > 80dB	
Operating Environment	Temperature: -10 to +50 $^{\circ}$ C ambient Humidity: 100% Storage: -20 to +50 $^{\circ}$ C ambient IP69K	
Case Materials	PC+Polyester alloy, PBT, Silicon Rubber, SS304 Stand	
Packing Weights	Basic Indicator: 2.0kg	
Digital		
Display	LED Backlit LCD with six 20mm high digits with units and annunciators	
Setup and Calibration	Full digital with visual prompting in plain messages	
Digital Filter	Sliding window average from 0.1 to 4.0 seconds	
Zero Range	Adjustable from \pm 2% to \pm 20% of full capacity	
Power Input		
Standard Power Input	12 to 24VDC, 9.6, 12 and 24V batteries (2.5 VA max) - ON/OFF key with memory feature	
Variants	AC	AC Power supply: 110/240VAC 50/60Hz in 12VDC 1.2A out
	Battery	12V battery pack (rechargeable NiMH)
Features		
opto-LINK Data Coupling	Infra-red Connector for optional opto-LINK PC cable (to USB or RS-232 PC port)	
Correction	Ten point linearity correction	
Outputs	RS-232 automatic transmit, network or printer outputs. Transmission rate: 2400, 4800 or 9600 baud	
Assignable Function Key	Unit switching, counting, manual hold, peak hold, live weight and totalising	
Drive Outputs	3 isolated high side drive outputs (400mA each 12-24VDC)	
Battery Backed Clock Calendar	Battery life 10 years minimum	

4. Warnings

4.1. General

- Indicator not to be subject to shock, excessive vibration or extremes of temperature (before or after installation).
- Inputs are protected against electrical interference, but excessive levels of electro-magnetic radiation and RFI may affect the accuracy and stability.
- For full EMC or for RFI immunity, termination of cable shields and correct earthing of the instrument is essential.
- Indicator and load cell cable are sensitive to excessive electrical noise. Install well away from any power or switching circuits.

4.2. Configuration Issues

- Configuration and calibration can be performed from the front panel, using digital setup. When Full Setup is used, all menu items are accessible and care must be taken to ensure no accidental changes are made to calibration and trade settings.
- Enter a passcode to prevent unauthorised or accidental tampering. If the passcode is lost, the manufacturer should be contacted for further advice.

5. Installation

The following steps are required to set up the indicator.

- Inspect indicator to ensure good condition.
- Use connection diagrams to wire up load cell, power and auxiliary cables as required.
- Connect Power to indicator and press **<POWER>** key to turn the instrument On.
- Refer to the Instrument Setup section page 15 for information on configuring and calibrating the instrument.
- To turn instrument Off press and hold **<POWER>** key for three seconds (until display blanks).

5.1. Electrical Safety

- For your protection all mains electrical hardware must be rated for environmental conditions of use.
- Pluggable equipment must be installed near an easily accessible power socket outlet.
- To avoid the possibility of electric shock or damage to the instrument, always switch off or isolate the instrument from the power supply before maintenance is carried out.

5.2. opto-LINK

The optional opto-LINK cable can be used to transfer setup and calibration information from a PC (eg. to be stored for later use and/or transferred to other instruments). It can also be used to download software upgrades to the instrument from a PC.



- Attach the opto-LINK cable to the PC using the USB or DB9 connector.
- Attach the opto-LINK head to the left side of the instrument display using the permanent magnet located within the head of the opto-LINK.

WARNING: The opto-LINK head contains a strong magnet and care should be taken with its proximity to electronic media (eg. credit cards, floppy disks, etc.) and/or other electronic instrumentation.

5.2.1. opto-LINK Activation

A long press of the **<GROSS/NET>** key will toggle the opto-LINK infrared communications On/Off.

When the opto-LINK has been (enabled) the following will occur:

- The instrument briefly displays the prompt **opto-L**.
- The editing annunciators (ie. GRP, ITM, etc.) will flash for up to five minutes while the instrument searches for activity. During this period, the instrument also disables the RS-232 communications.
- **Activity Located:** If the instrument is **successful** in locating activity, the editing annunciators will continue to flash during the entire period of communications.
- **No Activity Located:** If the instrument **fails** to locate activity, the opto-LINK will be disabled and the editing annunciators will stop flashing. The instrument will also revert back to the normal RS-232 communications (ie. the SERIAL:TYPE setting will be re-activated).

6. Connections

6.1. Cable Connections

- All cable connections are made to the rear of the instrument using pluggable screw terminals.

LOAD CELL CONNECTIONS

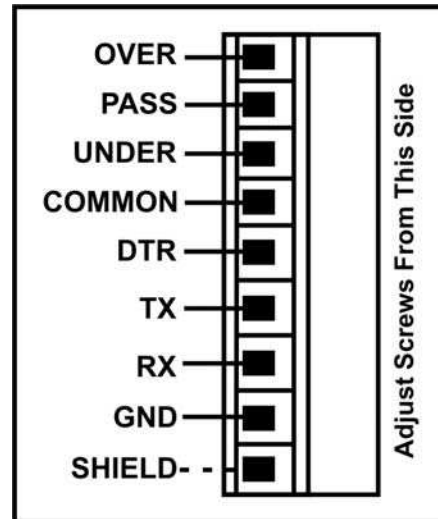
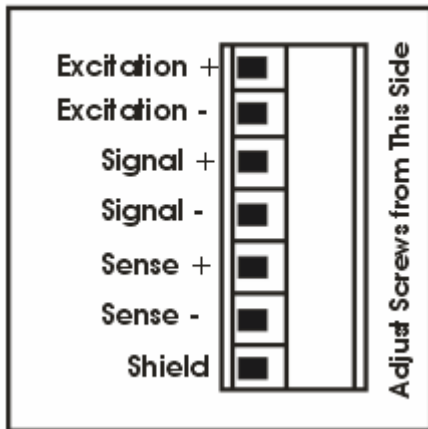

6.2. DC Power (DC PWR + , DC PWR –)

- The DC supply need not be regulated, provided that it is free of excessive electrical noise and sudden transients.
- The instrument can be operated from a high quality plug-pack as long as there is sufficient capacity to drive both it and the load cells.

6.3. Load Cell Connection

The instrument may be connected for either 4-wire or 6-wire operation. For more information, refer to **BUILD:CABLE** setting page 17.

6.3.1. 4-Wire Connection

The minimum connectivity requirements are the connection of four wires (ie. Excitation + and – along with Signal + and –).

The BUILD:CABLE option must be set to **4** to allow for 4-wire connection.

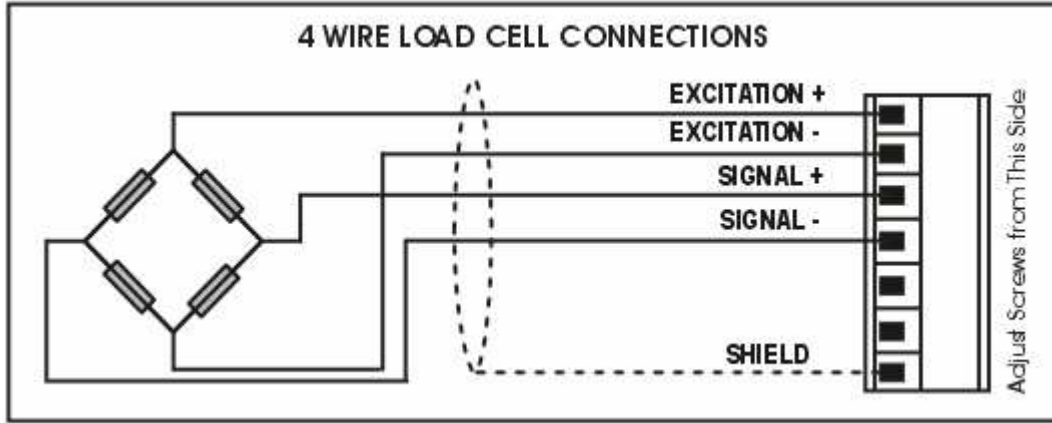

6.3.2. 6-Wire Connection

The excitation and signal lines are connected the same as for a 4-wire installation.

The BUILD:CABLE option must be set to **6** (the default) to allow for 6-wire connection.

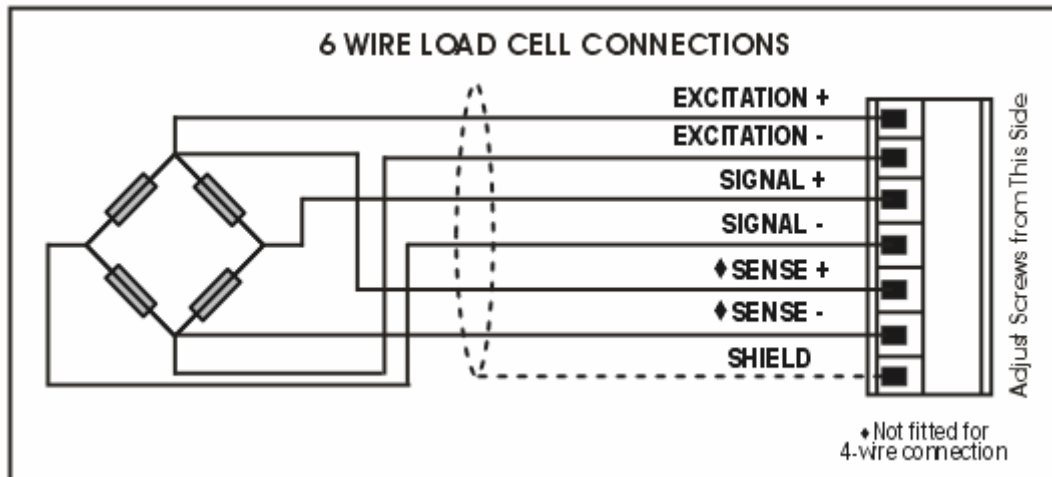

6.4. Auxiliary Connections

This section provides diagrams to illustrate the terminal connections.

6.4.1. Direct Personal Computer Link (RXD, TXD, GND)

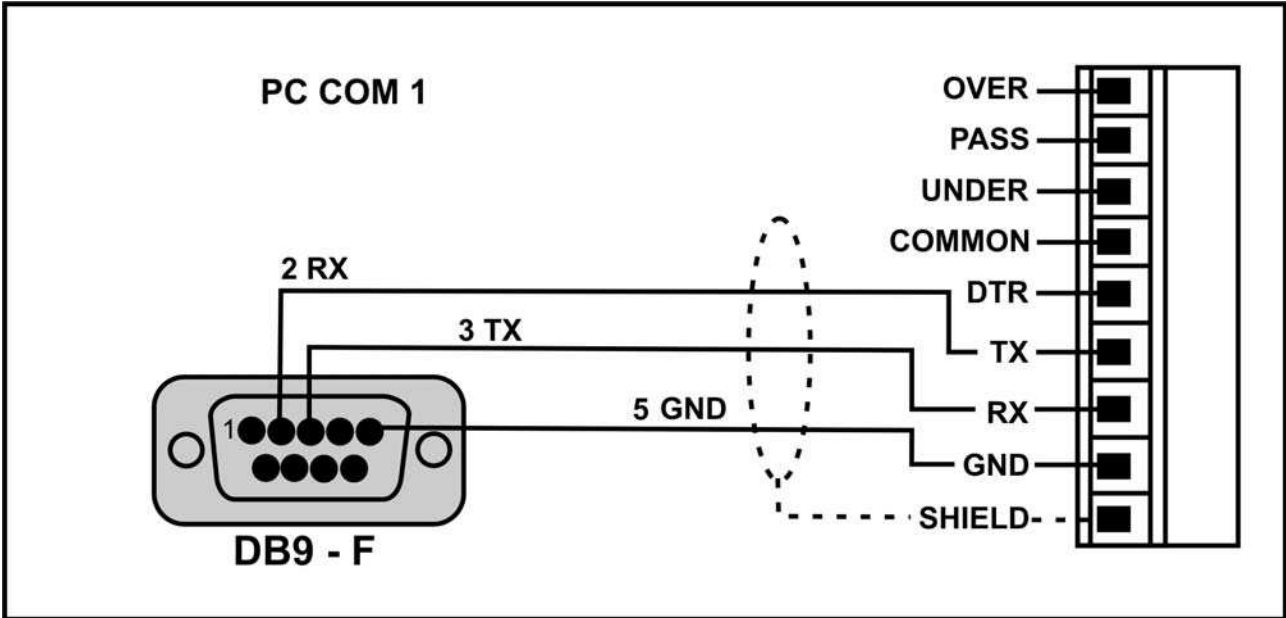

RS-232 - Instrument to PC using COM Port (DB9)

RS-232 - Instrument to PC using COM Port (DB25)

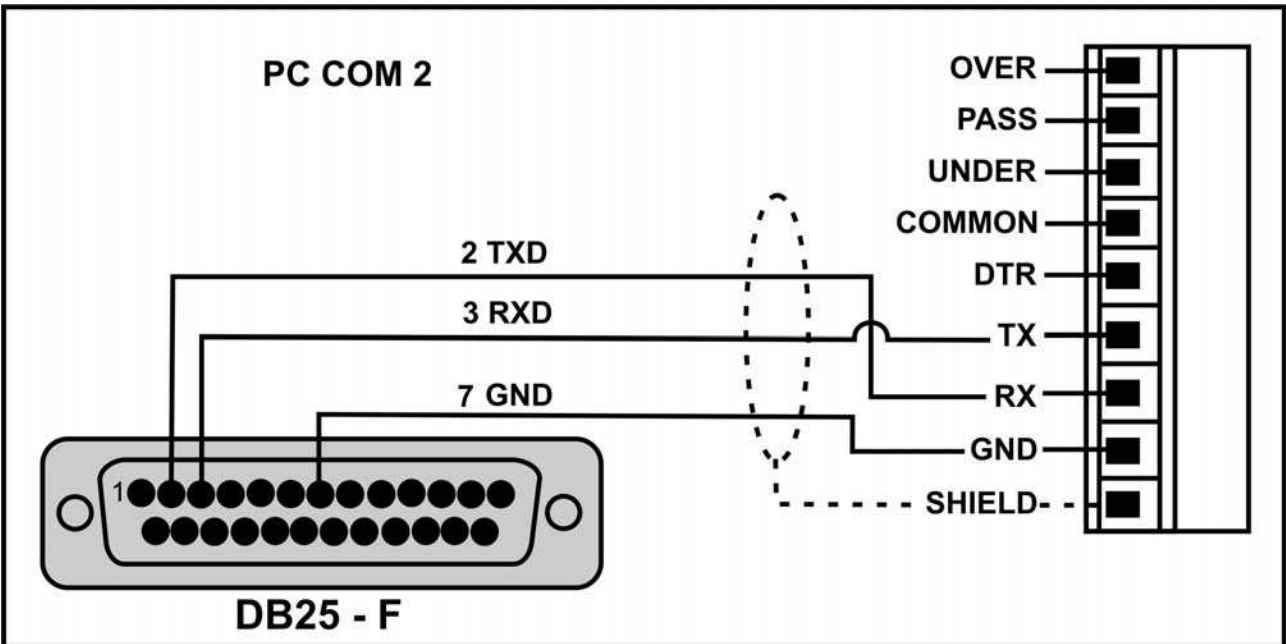

6.4.2. Printer Connections (RXD/TXD, GND and DTR) RS-232 – Instrument to Printer (DB25)

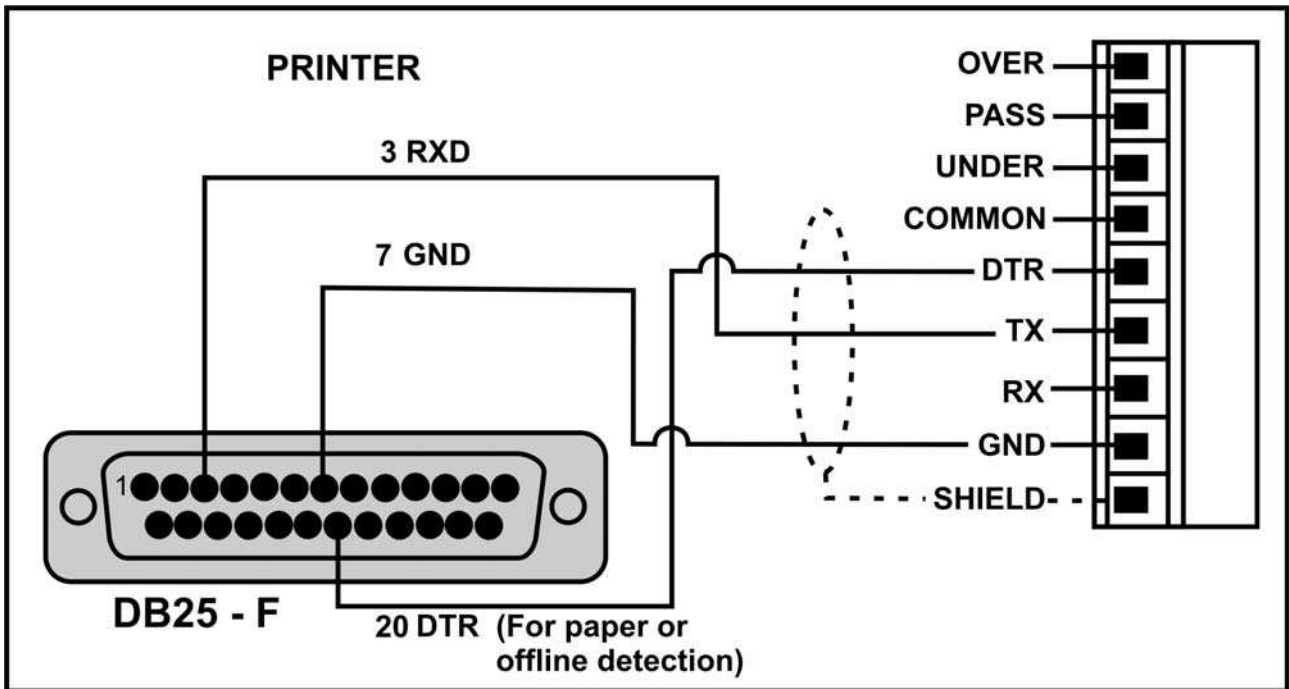

6.4.3. Remote Display (TXD, GND)

- Connect TXD to RXD and GND to GND on the remote display.

6.4.4. Remote Input

- The indicator requires a voltage free contact between TXD and RXD to enable the remote input (ie. SPEC:REM.FN).
Note: The remote input will not function when in setup or when using the opto-LINK.

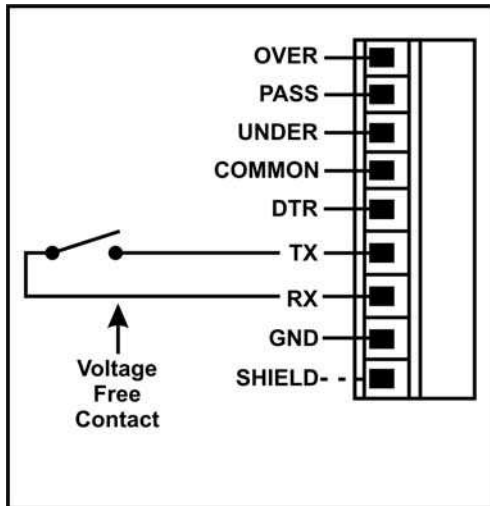

WARNING

The remote input is a voltage free contact (eg. button, mechanical relay). Connection of any active circuitry may damage the instrument.

6.4.5. Outputs

- The output drivers for the instrument are high side drive and are capable of driving up to 400mA each.
- This configuration allows for the direct connection of the instrument outputs to most types of PLC.
- The voltage applied to the instrument's positive power supply terminal (+) appears on the output lines when the outputs are active.
- To drive external loads (eg. relays), connect the output line directly to the positive side of the relay coil. Connect the negative side of the relay coil to COMMON.
- It is recommended that fly-back diodes or transient suppressors be fitted across inductive loads such as relay coils to limit switching noise.

Outputs to Drive Relay

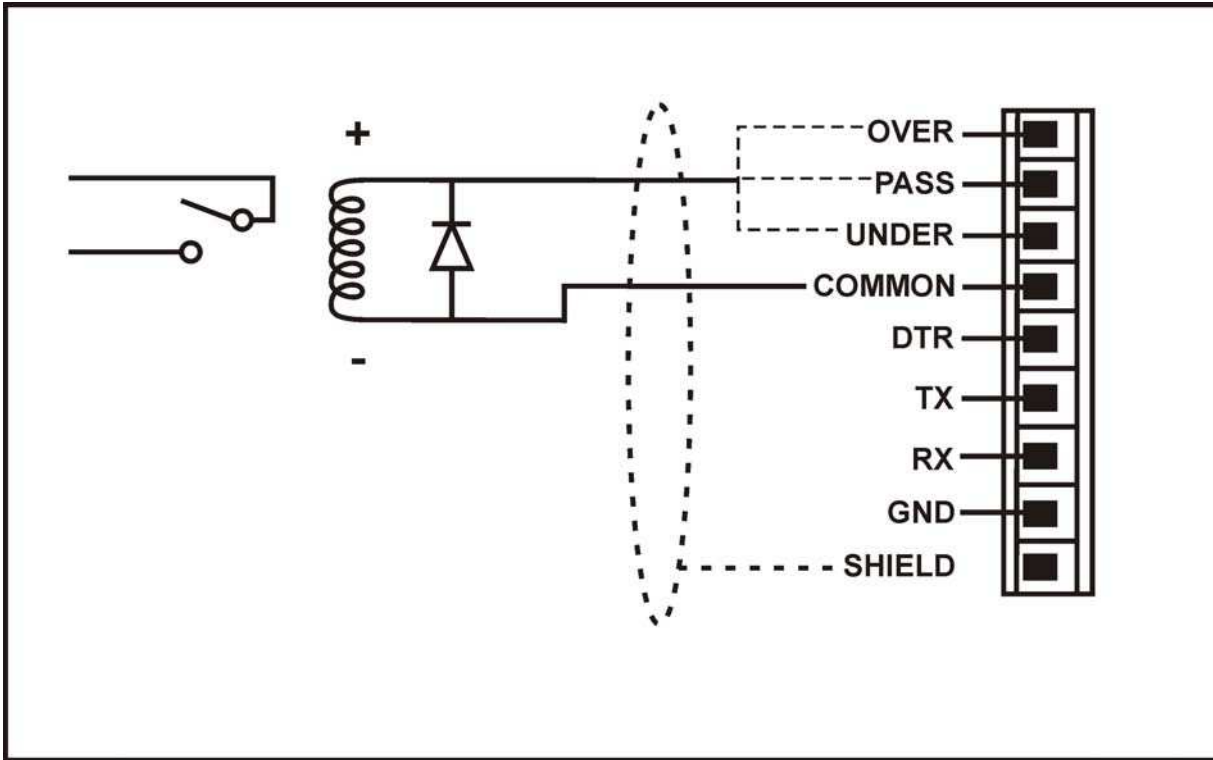

Outputs to Drive PLC

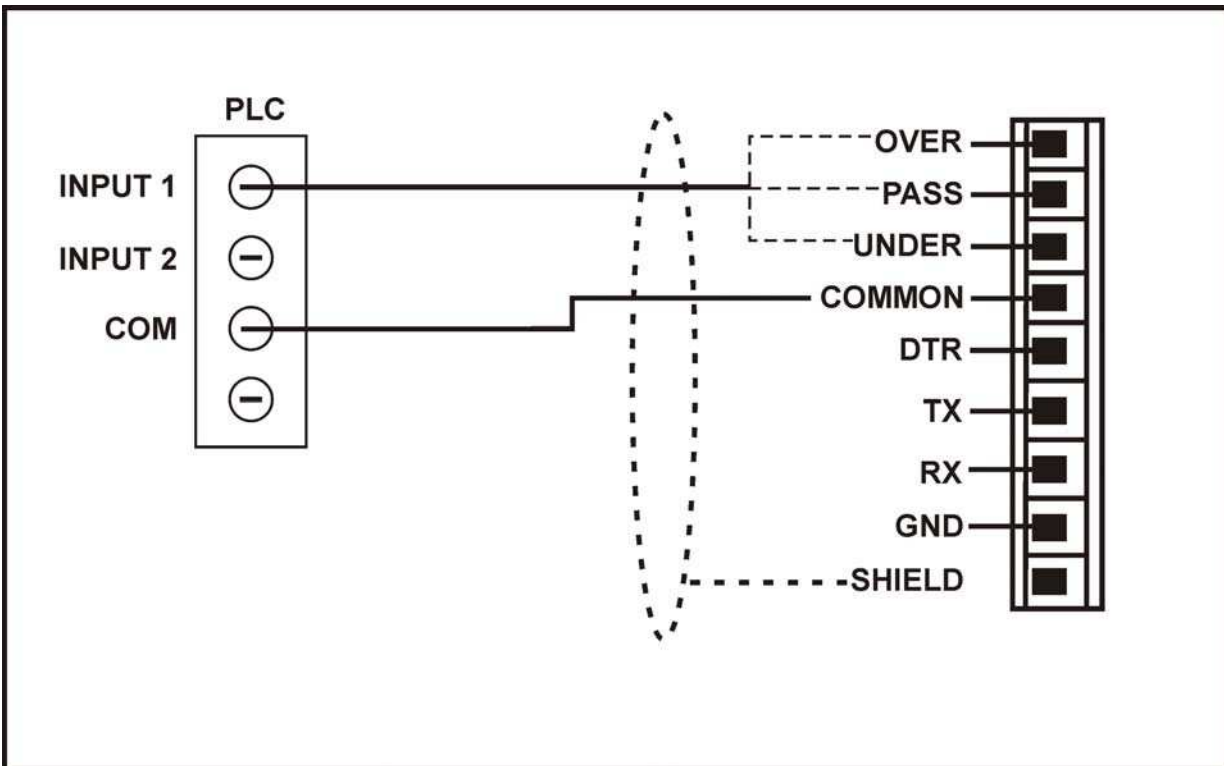

6.5. Connecting Shields

To obtain full EMC or for RFI immunity, cable shields MUST be connected to the earth lug on the rear of the instrument.

6.5.1. Cable Shield Connection and Earthing

- Care should be taken when connecting shields to maximise EMC or RFI immunity and minimise earth loops and cross-talk (interference) between instruments.
- For full EMC or for RFI immunity, termination of the cable shields at the earth lug is very important. The earth lug of the instrument must be separately connected to ground potential via a reliable link.
- The instrument should only be connected to earth via a single reliable link to avoid earth loops.
- Where each instrument is separately earthed, interconnecting cable shields should be connected at one end only.
- **Caution:** Some load cells connect the cable shield directly to the load cell (and therefore the scale base). Connection of the load cell cable shield in this situation may be site specific.

6.6. Regulatory Sealing Requirements

To comply with regulatory sealing requirements for each instrument, (ie. to ensure instruments are not accidentally or deliberately tampered with), it is important that proper sealing procedures be adhered to.

6.6.1. Sealing

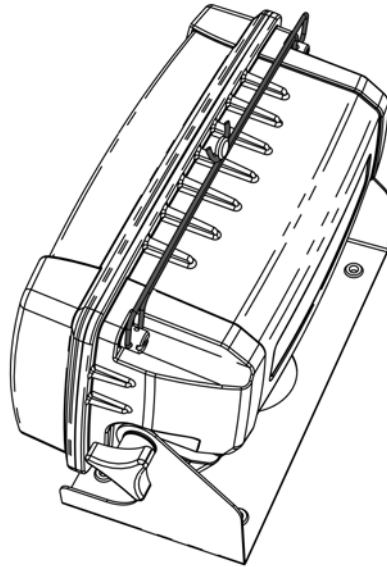

Attachment of Lead Seal through optional Captive Security Screws. Please note that security screws are available as an option and that they are less corrosion resistant than the standard Captive Screws.

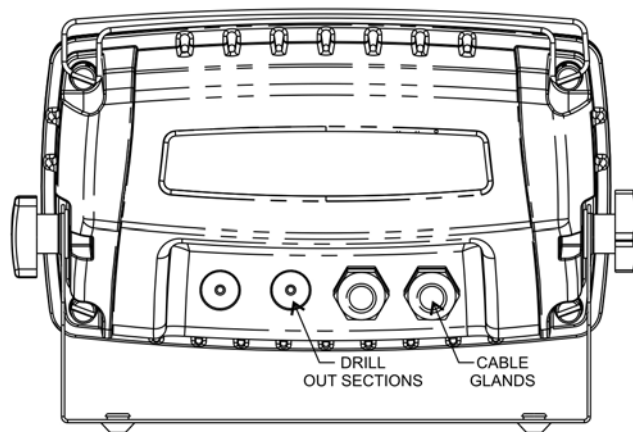

Back View showing cable locations.

7. Instrument Setup

7.1. Calibration Counter

The built-in calibration counter(s) monitor the number of times trade critical settings are altered. Refer to Trade Critical Settings below for more information and to the **OPTION:USE** setting page 17.

The table below describes when the counter(s) will increment.

Industrial or OIML: The **Calibration Counter** increments when trade critical settings are changed. An example of the counter is **C.00019**.

NTEP: Two counters display.

The **Calibration Counter** increments when trade critical settings in the Calibration (**CAL**) menu are changed. An example of the counter is **C.00010**.

The **Configuration Counter** increments when other trade critical settings (ie. **not** in the **CAL** menu) are changed. An example of the counter is **F.00009**.

7.1.1. Trade Critical Settings

Trade critical settings can affect calibration and/or legal for trade performance. In this document the ⊗ symbol indicates the setting is trade critical. Each time a trade critical setting is altered, the calibration counter will be incremented by one.

7.2. opto-LINK

For information on setting up using the opto-LINK cable refer to opto-LINK page 6.

7.3. Access Full Setup

Full Setup provides access to configure and calibrate the instrument. All items in all menus will be enabled in Full Setup.

WARNING: Care should be taken to avoid inadvertently altering the Build or Calibration settings.

- Ensure the instrument is on.
- Press and hold the **<POWER>** and **<GROSS/NET>** keys together for two seconds.



7.4. Access Safe Setup

Safe Setup restricts access to the trade critical settings (marked with ⊗).

- Ensure the instrument is on.
- Press and hold the **<POWER>** and **<TARE>** keys together for two seconds.



7.5. Exit Full or Safe Setup

To save settings, exit setup and return to the normal weighing mode use one of the following methods:





- **Method 1:** Press **<POWER>** and **<GROSS/NET>** keys together for two seconds.
- **Method 2:** Press **<POWER>** and **<TARE>** together for two seconds.
- **Method 3:** Select **- End -** from the menus.

Warning: If the power is interrupted while in setup (ie. by disconnecting the power cable or pressing the **<POWER>** key), unsaved settings will be lost.





7.6. Settings

The following tables identify the settings available for the instrument.





Quick Start Manual Rev 1.2

GROUP (GRP)	ITEM (ITM)	SELECT (SEL)	EDIT (EDT)	OK
 ZERO	 TARE	 GROSS / NET	 PRINT	 FUNCTION
			Underline = Defaults	
BUILD	DP⊗	Decimal Point Position	<u>000000</u> , 00000.0, 0000.00, 000.000, 00.0000, 0.00000	Accept
	CAP⊗	Maximum Capacity	000100 to 999999 Default = <u>003000</u> <SEL> changes position, <EDT> changes digit.	Accept
	RES⊗	Resolution (Count-By)	<u>1</u> , 2, 5, 10, 20, 50, 100	Accept
	UNITS⊗	Weighed Units	none, g, <u>kg</u> , lb, t	Accept
	HI.RES⊗	Resolution x 10 Mode	<u>OFF</u> , ON	Accept
	CABLE⊗	4-Wire or 6-Wire	4, <u>6</u>	Accept
OPTION	USE⊗	Scale Use	<u>INDUST</u> , OIML, NTEP	Accept
	FILTER	Reading Average (time in seconds)	none, 0.2, <u>0.5</u> , 1.0, 2.0, 3.0, 4.0	Accept
	MOTION⊗	Motion Detection	OFF, <u>0.5-1.0</u> , 1.0-1.0 Default = 0.5 Graduations per Second	Accept
	INIT.Z	Initial Zero on Startup	<u>OFF</u> , ON	Accept
	Z.TRAC⊗	Zero Tracking Sensitivity	<u>OFF</u> , SLOW (0.5 grads/sec), FAST (10 grads/sec)	Accept
	Z.RANGE⊗	Zero Operating Range	<u>-2_2</u> , -1_3, -20_20 Default = -2_2 (-2% to +2%)	Accept
	Z.BAND⊗	Zero 'Dead' Band	<SEL> changes position, <EDT> changes digit. Default = <u>0</u>	Accept
R.ENTRY⊗	Enable Rear Pushbutton for Full Setup Entry	<u>OFF</u> , ON	Accept	





Quick Start Manual Rev 1.2

GROUP (GRP)	ITEM (ITM)	SELECT (SEL)	EDIT (EDT)	OK
				
Underline = Defaults				
CAL	ZERO⊗	Zero Calibration Routine Set between zero and full scale (Current weight displays)	<SEL> key to start. Current weight displays. Remove all weight. <SEL>, <EDT> or <OK> starts routine (Z.in P displays). <ITM> key to exit, <SEL>, <EDT> or <OK> to repeat routine.	
	SPAN⊗	Span Calibration Routine Set between zero and full scale (Current weight displays)	<SEL> key to start <EDT> key to select clear linearisation points (CLr.L y displays). or not (CLr.L n displays). <OK> key to select alternative. Current weight displays. Add test weight. <SEL> or <OK> to show calibration weight value. Set correct weight. <SEL> changes position, <EDT> changes digit. <ITM> or <OK> starts routine (S.in P displays). <ITM> key to exit, <SEL>, <EDT> or <OK> to re-edit calibration weight and repeat routine.	





Quick Start Manual Rev 1.2

GROUP (GRP)	ITEM (ITM)	SELECT (SEL)	EDIT (EDT)	OK
				
Underline = Defaults				
CAL (ctd)	ED.LIN⊗	Edit Linearisation Points Set between zero and full scale L1. - - - Select Linearisation point 1 to 10 (L1, L2, L3, L4, L5, L6, L7, L8, L9, L10). (Approx. % of full scale)	<SEL> to step through list of points. <OK> to change selected point or <ITM> to exit. After <OK> current weight displays. Add test weight. <OK> to enter corrected weight. <SEL> changes position, <EDT> changes digit. <OK> starts routine (L.in P displays). <ITM> key to exit, <OK> to repeat routine.	
	CLR.LIN⊗	Clear Linearisation Points L1. - - - Select Linearisation point 1 to 10 (L1, L2, L3, L4, L5, L6, L7, L8, L9, L10)	<SEL> to step through list of points. <OK> to select point to clear or <ITM> to exit. After <OK> press <ITM> to choose Cont. Y (Yes) or Cont. N (No). <ITM> to return to CLR.LIN.	
	DIR.ZER⊗	Direct Zero Calibration (Current weight displays)	<OK> key to start. Current weight displays. <OK> to enter direct zero setting (in mV/V). <SEL> changes position, <EDT> changes digit. <OK> key to store new zero calibration. <ITM> to exit or <OK> to repeat operation.	





Quick Start Manual Rev 1.2

GROUP (GRP)	ITEM (ITM)	SELECT (SEL)	EDIT (EDT)	OK
				
Underline = Defaults				
CAL (ctd)	DIR.SPN⊗	Direct Span Calibration (Current weight displays)	<OK> key to start. Current weight displays. <OK> to enter direct span setting (in mV/V). <SEL> changes position, <EDT> changes digit. <OK> key to store new span calibration. <ITM> to exit or <OK> to repeat operation.	
	FAC.CAL⊗	Factory Calibration Cont. N (No) Cont. Y (Yes)	<u>Cont. N</u> Warning: Choosing Cont. Y will restore default factory calibration in BUILD and CAL menus.	Accept
SPEC	SAFE.PC	Safe Setup Passcode	<u>(000000)</u> no passcode). Set up to 6 digit passcode. <SEL> changes position, <EDT> changes digit. Activated only when FULL.PC is also set.	Accept
	FULL.PC	Full Setup Passcode	<u>(000000)</u> no passcode). Set up to 6 digit passcode. <SEL> changes position, <EDT> changes digit.	Accept
	KEY.LOC	Front Panel Key Locking P12345 (P for Power key. Other keys numbered from the left, ie. Zero=1.)	<u>P12345</u> Character indicates key is unlocked. (-) Dash indicates key is locked. <SEL> changes position, <EDT> changes digit.	Accept
	KEY.FN	<FUNCTION> Key Setting	<u>NONE</u> , TEST, COUNT, UNITS, HOLD, PEAK.H, LIVE.WT, SHOW.T, HI.RES, A.TARE, CHECK.W	Accept





Quick Start Manual Rev 1.2

GROUP (GRP)	ITEM (ITM)	SELECT (SEL)	EDIT (EDT)	OK
				
			Underline = Defaults	
SPEC (ctd)	AUT.OFF	Auto Power Off / Battery Operation	<u>NEVER</u> , 1, 5, 10 (time in minutes) Default = Never powers off automatically (Battery: powers down after 30 minutes)	Accept
	B.LIGHT	Backlight Operation	<u>ON</u> , OFF, FORCED (Battery: Automatically turns backlight off after 10 seconds of inactivity)	Accept
	REM.FN	Remote Function	<u>NONE</u> , KEY1 to KEY5, BLANK (Activated only when SERIAL:TYPE is set to AUTO)	Accept
	BAT.VLT	Battery Voltage	<u>PWR</u> , 9.6, 12, 24	Accept
	W.D.LOCK	Wash Down Key Lock	<u>OFF</u> , ON (On requires correct sequence of keys pressed on startup)	Accept
SERIAL	TYPE	Serial Output Type	<u>NET</u> , AUTO, SINGLE, PRINT, AUTO.PR	Accept
	FORMAT	Serial Output Format	<u>MASTER</u> , CUSTOM, FMT_1, FMT_2,	Accept
	BAUD	Serial Baud Rate	2400, 4800, <u>9600</u>	Accept
	BITS	Serial Format Options Position 1: Parity Position 2: Data Bits Position 3: Stop Bits Position 4: DTR Handshake	<u>N 8 1</u> - (Default Serial Format Options) <SEL> changes position, <EDT> changes digit. Parity: N None, O Odd, E Even Data Bits: 7 or 8 data bits Stop Bits: 1 or 2 stop bits DTR: (-) DTR disabled or d DTR enabled	Accept





Quick Start Manual Rev 1.2

	ADDRES	Instrument Address	01 to <u>31</u> <SEL> changes position, <EDT> changes digit.	Accept
GROUP (GRP)	ITEM (ITM)	SELECT (SEL)	EDIT (EDT)	OK
				
			Underline = Defaults	
SERIAL (ctd)	RST.CON⊗	Reset Printed Consecutive Numbers to 1 Cont. N (No) Cont. Y (Yes)	<u>Cont. N</u> <ITM> to choose Cont. Y (Yes) or Cont. N (No)	Accept
CHECK.W	ENABLE	Enable Check Weighing	<u>OFF</u> , ON	Accept
	SRC	Weight Source	<u>GROSS</u> , DISP, NET (Displayed)	Accept
	OVER	Target for Over Weight	-99999 to 999999 Default = <u>000000</u>	Accept
	UNDER	Target for Under Weight	-99999 to 999999 Default = <u>000000</u>	Accept

Quick Start Manual Rev 1.2

GROUP (GRP)	ITEM (ITM)	SELECT (SEL)	EDIT (EDT)	OK
 ZERO	 TARE	 GROSS / NET	 PRINT	 FUNCTION
			Underline = Defaults	
CLOC	FORMAT	Date Format Setting	<u>dd.mm.yy</u> or mm.dd.yy	Accept
	YEAR	Year Setting	2000 to 2099 <SEL> changes position, <EDT> changes digit.	Accept
	MONTH	Month Setting	01 to 12 <SEL> changes position, <EDT> changes digit.	Accept
	DAY	Day Setting	01 to 31 <SEL> changes position, <EDT> changes digit.	Accept
	HOUR	Hour Setting	00 to 23 <SEL> changes position, <EDT> changes digit.	Accept
	MINUTE	Minute Setting	00 to 59 <SEL> changes position, <EDT> changes digit.	Accept
TEST	SCALE	Scale Base Test Display	Display reads in milliVolts-per-Volt (factory calibrated to 0.1%) Verify the correct load cell capacity and/or load cell wiring is used. Remove weight from scale.	
	FRC.OUT	Force Outputs	<EDT> advances through outputs (ie. ON.1 and ON.2) <OK> turns outputs off and exits test. Default = <u>OFF</u>	
	O.LOAD	Input Overload Count	Displays the number of occurrences of an input overload.	Return

Quick Start Manual Rev 1.2

GROUP (GRP)	ITEM (ITM)	SELECT (SEL)	EDIT (EDT)	OK
				
Underline = Defaults				
TEST (ctd)	CLR.OLD	Clear Overload Count Cont. N (No) Cont. Y (Yes)	<u>Cont. N</u> Choosing Cont. Y will clear the overload count.	Accept
FACTRY	DEFLT	Restore Factory Defaults Cont. N (No) Cont. Y (Yes)	<u>Cont. N</u> Warning: Choosing Cont. Y will clear all stored data except BUILD and CAL menus.	Accept
- END -	EXIT SETUP	Save settings and return to normal weighing mode		Accept

8. Error Messages

8.1. Weighing Errors

- Check Setup = This item can be checked on site by service personnel

Error	Description	Resolution
(U - - - - -)	The weight is below the minimum allowable weight reading.	Increase the weight or decrease the minimum allowable weight reading.
(O - - - - -)	The weight is above the maximum allowable weight reading. Warning - overloading may damage mechanical scale elements.	Check the condition of load cell connections. Check for damaged load cell.
(ZERO) (ERROR)	The weight reading is beyond the limit set for Zero operation. The operation of the <ZERO> key is limited in the setup during installation. The indicator cannot be Zeroed at this weight.	Increase the Zero Range (Z.RANGE) or use the <TARE> key instead.
(STABLE) (ERROR)	Scale motion has prevented a <ZERO> , <TARE> or <PRINT> operation from occurring on command.	Try the operation again once the scale is stable.

8.2. Setup and Calibration Errors

Error	Description	Resolution
(ENTRY) (DENIED)	The instrument may be in Safe Setup and an item that needs Full Setup has been selected for editing.	Access Full Setup to edit the item.
	When accessing setup, more than three attempts have been made with the incorrect passcode.	Turn the instrument off. When the instrument is turned back on, enter the correct passcode to access setup.
(LIN.PT) (LO)	An attempt has been made to place a linearisation point below zero.	Incorrect linearisation point entered (must be between zero and full scale).
(PT.TOO) (CLOSE)	An attempt has been made to place a calibration point too close to an existing calibration point.	Re-enter the calibration point. Points must be spaced by at least 2% of full scale from each other.
(RES) (LO)	The scale build is configured for less than 100 graduations.	Check the resolution (count-by) and capacity settings.
(RES) (HIGH)	The scale build is configured for more than 30,000 graduations.	Check the resolution (count-by) and capacity settings.
(SPAN) (LO)	The load cell signal range (span) is too small for these settings.	Incorrect span weight entered (must be between zero and full scale). Scale wiring incorrect. Wrong load cell capacity (too large). Wrong or no calibration weight added to scale.
(SPAN) (HI)	The load cell signal range (span) is too large for these settings.	Incorrect span weight entered (must be between zero and full scale). Scale wiring incorrect. Load cell capacity too small for application.
(ZERO) (LO)	An attempt has been made to calibrate zero below -2mV/V.	Scale wiring incorrect.
(ZERO) (HI)	An attempt has been made to calibrate zero above +2mV/V.	Remove all weight from scale. Scale wiring incorrect.

8.3. Diagnostic Errors

- Check: This item can be checked on site by service personnel.
- Return for Service: The instrument must be returned to the manufacturer for factory service.

Error	Description	Resolution
(E0001)	The power supply voltage is too low.	Check supply
(E0002)	The power supply voltage is too high.	Check scale / cables
(E0010)	The temperature is outside of allowable limits.	Check location
(E0020)	Scale build is incorrect. The number of graduations has been set too low or too high.	Fix up scale build
(E0100)	The digital setup information has been lost.	Re-enter setup
(E0200)	The calibration information has been lost.	Re-calibrate
(E0300)	All setup information has been lost	Enter setup and calibrate
(E0400)	The factory information has been lost.	Return for Service
(E0800)	The EEPROM memory storage chip has failed	Return for Service
(E2000)	ADC Out of Range Error. This may be caused from a broken load cell cable.	Check BUILD:CABLE setting. Check load cell cable, wiring, etc.
(E4000)	The battery backed RAM data has lost data.	Re-enter setup
(E8000)	The FLASH program memory is incorrect	Return for Service

The **E** type error messages are additive. For example if instrument is running off batteries and the temperature drops, the battery voltage may be too low. The resulting error messages will be **E0011** (0001 + 0010). The numbers add in hexadecimal as follows:

1 - 2 - 3 - 4 - 5 - 6 - 7 - 8 - 9 - A - B - C - D - E - F

(For example, 2 + 4 = 6, or 4 + 8 = C)

Notes:

Innovative Measurement Electronics



PT Ltd.

<http://www.pt-global.com>